

# INSTALLATION INSTRUCTIONS

COMMERCIAL  
THERMOSTAT  
P/N 33CS450-01

*Carrier*

## DIGITAL THERMOSTAT

**7-DAY  
PROGRAMMABLE**

HEAT & HEAT  
COOL PUMP

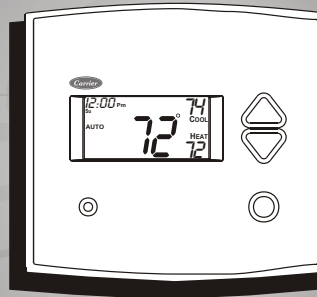

- 3 Configurable Outputs
- Control up to 3 Heat & 2 Cool Stages
- Adjustable 2nd & 3rd Stage Timers & Deadbands
- Backlit Display & Button
- Legends
- Aux-Heat Indicator
- Dry Contact Equipped
- Outdoor Sensor Ready with High/Low Readouts for the Day
- Set Point Limiting
- Economizer Control
- Preoccupancy Fan Purge
- Accepts EZ Programmer™
- Remote Averaging
- Programmable Output
- Light Activation Equipped
- Accepts Optional Humidity Module: Controls Humidification, Dehumidification and Reheat
- Accepts Optional IR Remote Control

### Accepts the **OPTIONAL HUMIDITY MODULE**

- Use with most Air Conditioning & Heating Systems including: 1 or 2 Stage Electric Cooling & 3 Stage Gas Heating, Heat Pump, Electric or Hydronic Heat.

Carrier Corporation 04/06



### CAUTION

Follow the Installation Instructions before proceeding.  
Set the thermostat mode to "OFF" prior to changing settings in setup or restoring Factory Defaults.



### CAUTION

NEVER PUT MORE THAN ONE JUMPER ON THE SAME MISC JUMPER BLOCK!

THIS MAY DAMAGE YOUR THERMOSTAT AND VOID YOUR WARRANTY.

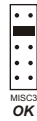

**NOTE:** Due to variations in environmental conditions, it is not always possible to achieve the desired humidification or dehumidification setpoint.

This device complies with Part 15 of the FCC Rules. Operation is subject to the following two conditions: (1) this device may not cause harmful interference, and (2) this device must accept any interference received, including interference that may cause undesired operation.

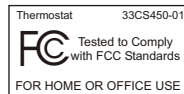



## *Table of Contents*

*Carrier*

|  |          |
|--|----------|
| <i>Preparation</i>                             | <b>1</b> |
| <i>Remove &amp; Replace the Old Thermostat</i> | <b>2</b> |
| <i>Configuring the MISC Outputs</i>            | <b>3</b> |
| <i>Wire Connections</i>                        | <b>4</b> |
| <i>Sample Wiring Diagrams</i>                  | <b>5</b> |
| <i>Test Operation</i>                          | <b>6</b> |
| <i>Calibrating the Thermostat Sensors</i>      | <b>7</b> |
| <i>TroubleShooting</i>                         | <b>8</b> |

## SECTION 1

### Preparation

Carrier

1



Proper installation of the thermostat will be accomplished by following these step by step instructions. If you are unsure about any of these steps, call a qualified technician for assistance.



Assemble tools



*Flat Blade  
Screwdriver*

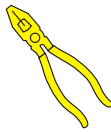

*Wire cutter  
& Stripper*



Make sure your Heater/Air Conditioner is working properly before beginning installation of the thermostat.



Carefully unpack the thermostat. Save the screws, bracket, and instructions.



Turn off the power to the Heating/Air Conditioning system at the main fuse panel. Most residential systems have a separate breaker for disconnecting power to the furnace.

## SECTION 2

### *Remove & Replace the Old Thermostat*

**2**



Remove the cover of the old thermostat.  
If it does not come off easily check for screws.



Loosen the screws holding the thermostat  
base or subbase to the wall, and lift away.



Disconnect the wires from the old thermostat.  
Tape the ends of the wires as you disconnect  
them, and mark them with the letter of the  
terminal for easy reconnection to the new  
thermostat.



Keep the old thermostat for reference purposes  
until your new thermostat is functioning properly.

**SECTION 3**  
*Configuring the MISC Outputs*

Carrier

**3**

**Section 3 Contents:**

- *Configuring the Jumpers.....3.2*
- *Explanation of Jumper  
Settings.....3.3*

### Configuring the Jumpers

3

For additional flexibility, your thermostat has three configurable outputs. These outputs are designed to have different functions depending on how the jumpers are set (*below*). Each output, labeled MISC1, MISC2, and MISC3 may be set for one of the six choices available. In the diagram below, the MISC3 jumper has been set for HUM\* (humidification) operation, the MISC2 jumper has been set for DEHUM\* (dehumidification) operation, and the MISC1 jumper has been set for PROG (programmable) operation.

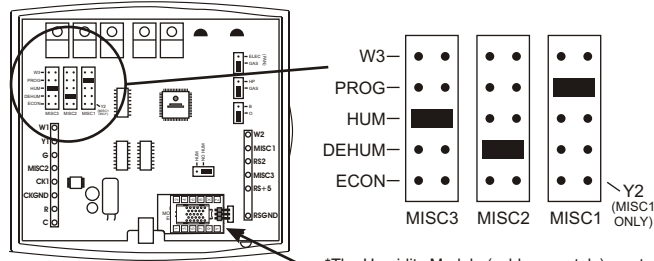

\*The Humidity Module (sold separately) must be installed to operate a humidification and/or dehumidification system.



#### CAUTION

**NEVER PUT MORE THAN ONE JUMPER ON THE SAME MISC JUMPER BLOCK!**

**DOING SO MAY DAMAGE YOUR THERMOSTAT AND VOID THE WARRANTY.**

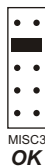





## Explanation of Jumper Settings

### 3 W3 JUMPER SETTING

If the jumper for MISC1, MISC2, or MISC3 is set to W3, the corresponding MISC screw terminal on the backplate will control a third stage of heat.

W3 MULTI-STAGE OPERATION EXPLAINED - SECTION 13 of the Owner's Manual

The 3rd Stage of Heat is turned on when:

(A) The 1st and 2nd stages have been on for the time required (steps 27 and 28, page 13.6). It is adjustable from 0-60 minutes and the default is two minutes.

And

(B) The temperature from the setpoint is equal to or greater than: the setpoint plus the 1st stage deadband (step #24, 13.5), plus the 2nd stage deadband (step #25, 13.5) plus the 3rd stage deadband (step #26, 13.5). This 3rd stage deadband is adjustable from 0-10 degrees and the default is two degrees.

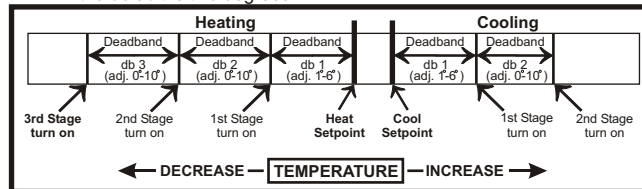

### PROG JUMPER SETTING

If the jumper for MISC1, MISC2, or MISC3 is set to PROG, the corresponding MISC screw terminal on the backplate will control a pilot relay or other accessory.

PROGRAMMABLE OUTPUT - SECTION 14 of the Owner's Manual

This jumper setting allows the MISC outputs to control a pilot relay by time, temperature, or a signal from the Internet/Phone. The following are three possible scenarios:

By **Time**: A device that requires a start and stop time. An example of this would be an exterior lighting system that needed to be energized every day between the hours of 8pm and 1am.

By **Temperature**: An exhaust fan that needs to energize whenever the temperature from RS2 rises above 90 degrees F.

By **Remote**: Remotely arming a security system through the web or phone.

## Explanation of Jumper Settings (continued)

### HUM JUMPER SETTING

3

*If the jumper for MISC1, MISC2, or MISC3 is set to HUM, the corresponding MISC screw terminal on the backplate will control a humidification system.*

HUMIDIFICATION OPERATION - SECTION 9 of the Owner's Manual

If your HVAC unit is equipped with a humidification system and the Humidity Module (sold separately) has been installed, the thermostat will provide power to the MISC1, MISC2, or MISC3 terminal of the thermostat when the humidity in the home falls below the humidity setpoint you have chosen. The value for this setpoint ranges from 0% to 60%. If no humidity is desired or if a humidification system has not been installed, set the value to OFF.

### DEHUM JUMPER SETTING

*If the jumper for MISC1, MISC2, or MISC3 is set to DEHUM, the corresponding MISC screw terminal on the backplate will be connected to the dehumidification terminal of a furnace board.*  
**NOTE:** Not all furnaces have a dehumidification terminal.

DEHUMIDIFICATION OPERATION - SECTION 10 of the Owner's Manual

If your HVAC unit is equipped with a dehumidification system the thermostat will operate in one of two ways.

- 1) **Normally Closed (NC):** The thermostat will **de-energize** the MISC1, MISC2, or MISC3 terminal of the thermostat (this MISC terminal is connected to the DEHUM terminal on your furnace) to allow the fan to run in low speed when the humidity in the home is above the dehumidify setpoint you have chosen and there is a call for 1st stage cooling.
- 2) **Normally Open (NO):** The thermostat will **energize** the MISC1, MISC2, or MISC3 terminal of the thermostat (this MISC terminal is connected to the DEHUM terminal on your furnace) to allow the fan to run in low speed when the humidity in the home is above the dehumidify setpoint you have chosen and there is a call for 1st stage cooling.

## Explanation of Jumper Settings (continued)

### 3 ECON JUMPER SETTING

*If the jumper for MISC2 and MISC3 is set to ECON, the corresponding MISC screw terminal on the backplate will be connected to an economizer.*

ECONOMIZER OPERATION - If your HVAC unit is equipped with an economizer system, the thermostat will provide power to the MISC1, MISC2, or MISC3 terminal of the thermostat when the thermostat is in an occupied time period. The MISC1, MISC2, or MISC3 terminal will be de-energized when the thermostat is in an unoccupied time period.

### Y2 JUMPER SETTING

*If the jumper for MISC1 is set to Y2 the MISC1 screw terminal on the backplate will control a second stage of cooling.*

Y2 OPERATION - SECTION 13 of the Owner's Manual

Control up to two Cool stages.

The **2nd Stage** of heat or cool is turned on when:

- (A) The 1st Stage has been on for the time required (*step #27, page 13.6*). It is adjustable from 0-60 minutes and the default is two minutes.

**And**

- (B) The temperature spread from the setpoint is equal to or greater than: *the setpoint plus the deadband (step #24, page 13.5), plus the 2nd deadband (step #25, page 13.5)*. This 2nd deadband is adjustable from 0-10 degrees and the default is two degrees.

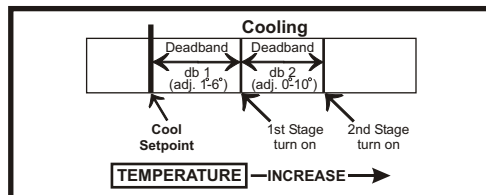

## SECTION 4

### Wire Connections



If the terminal designations on your old thermostat do not match those on the new thermostat, **refer to the chart below, or the wiring diagrams that follow.**

**4**

| Wire from the old thermostat terminal marked | Function                | Install on the new thermostat connector marked |
|--|-------------------------|--|
| G or F                                       | Fan                     | G  |
| Y1, Y or C                                   | Cooling                 | Y1   |
| W1, W or H                                   | Heating                 | W1/O/B   |
| Rh, R, M, Vr, A                              | Power                   | R  |
| C  | Common                  | C  |
| O/B  | Rev. Valve              | W1/O/B*  |
| W2   | 2nd Stage Heat          | W2   |
| MISC1  | Configurable Output #1  | MISC1  |
| MISC2  | Configurable Output #2  | MISC2  |
| MISC3  | Configurable Output #3  | MISC3  |
| RS+5   | Remote Sensor +5vdc     | RS+5**   |
| RS1  | Remote Sensor Signal    | RS1**  |
| RSGND  | Remote Sensor Ground    | RSGND**  |
| RS2  | Remote Sensor Signal #2 | RS2**  |
| CK1  | Dry Contact Switch 1    | CK1  |
| CKGND  | Dry Contact Switch 2    | CKGND  |

\* O/B is used if your system is a Heat Pump.

\*\* For instructions on connecting these terminals see page 15.2 of the Owner's Manual.

**SECTION 5**  
*Sample Wiring Diagrams*



**Section 5 Contents:**

|          |   |     |
|----------|---|-----|
| <b>5</b> | ▪ HVAC Equipment Wiring.....                              | 5.2 |
|          | ▪ MISC1, MISC2, and MISC3<br>Wiring.....                  | 5.6 |
|          | ▪ Remote Sensor and CK1-CK2<br>wiring for Time Clock..... | 5.8 |

**6 Wire, 1 Stage Cooling, 1 Stage Heat**

Residential & Commercial 1 Stage Cooling,  
with 1st Stage Gas Heat

OR

Commercial Heat Pump 1 Stage Cooling  
with 2 Stage Heat

5

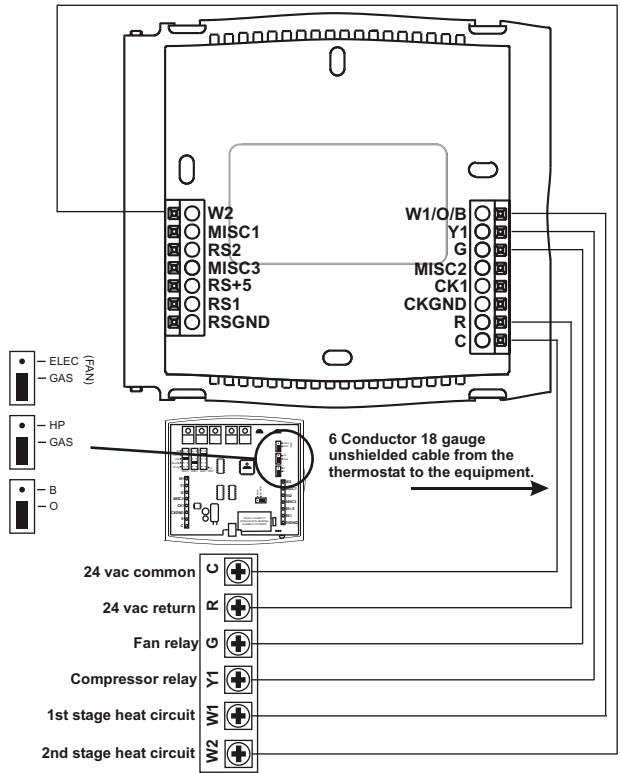

**6 Wire, 1 Stage Cooling, 1 Stage Heat**  
 Residential & Commercial 1 Stage Cooling,  
 with 1st Stage Electric Heat

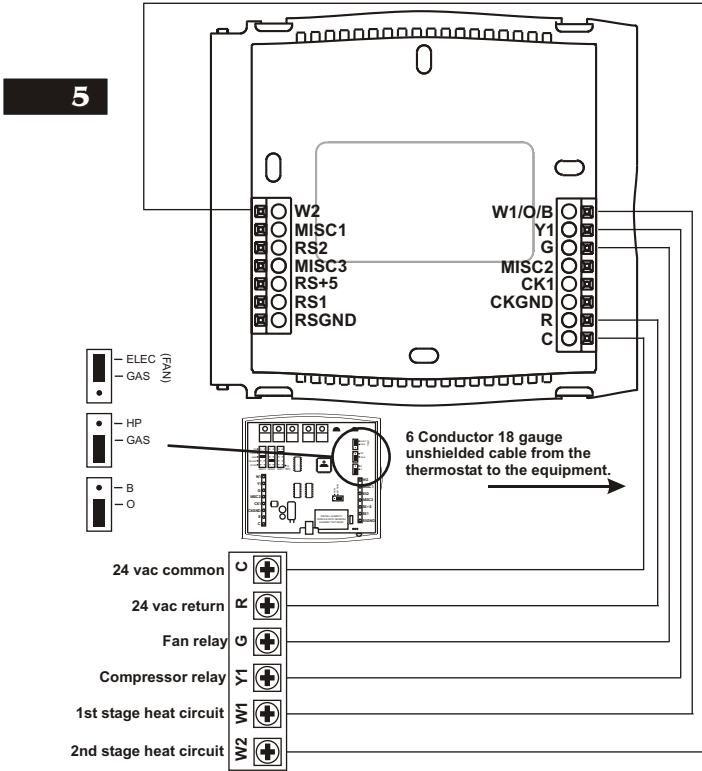

**6 Wire, 1 Stage Cooling, 2 Stage Heat**

Residential Heat Pump with O Reversing Valve 1 Stage Cooling, with 2 Stage Heat

**5**

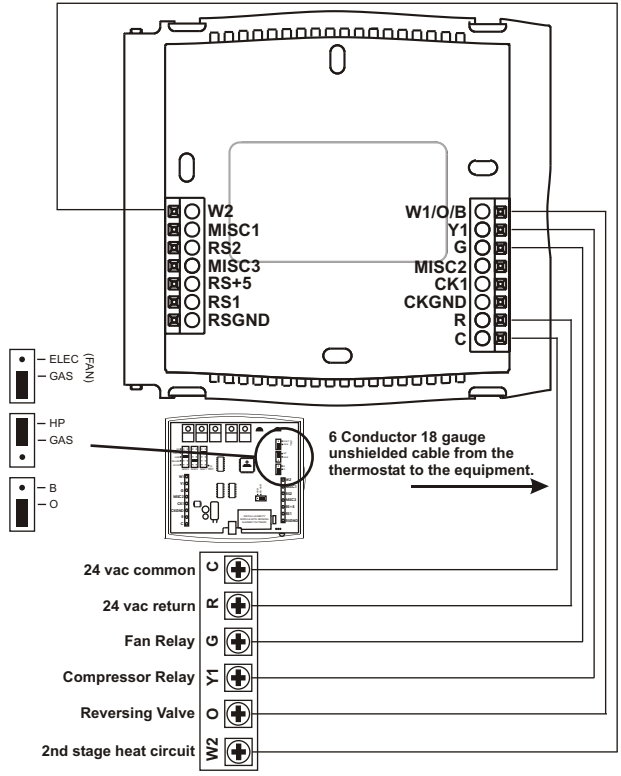



**6 Wire, 1 Stage Cooling, 2 Stage Heat**  
 Residential Heat Pump with b Reversing  
 Valve 1 Stage Cooling, with 2 Stage Heat

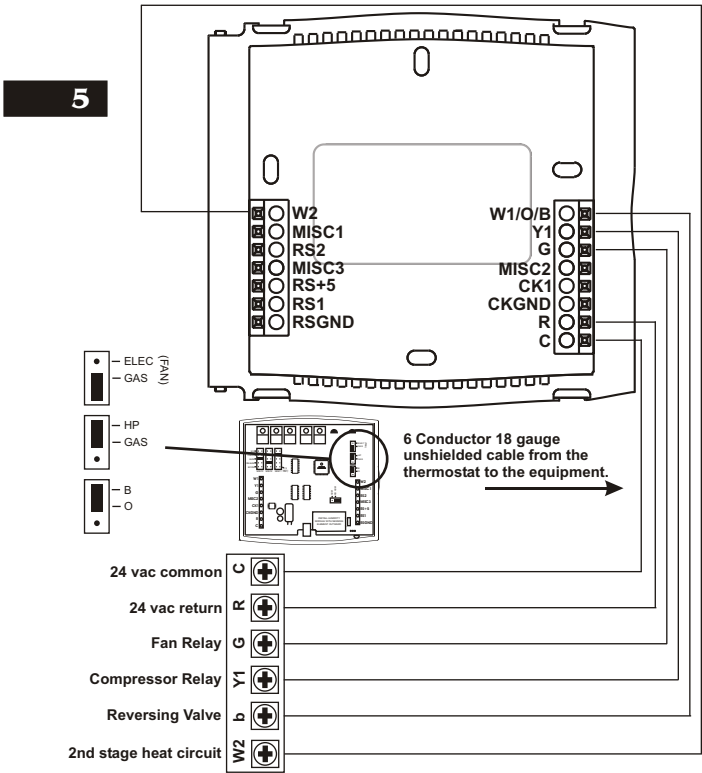

Adding a 2nd Stage of Cooling (MISC1), Exterior Lighting System (MISC2), and 3rd Stage of Heating (MISC3)

5

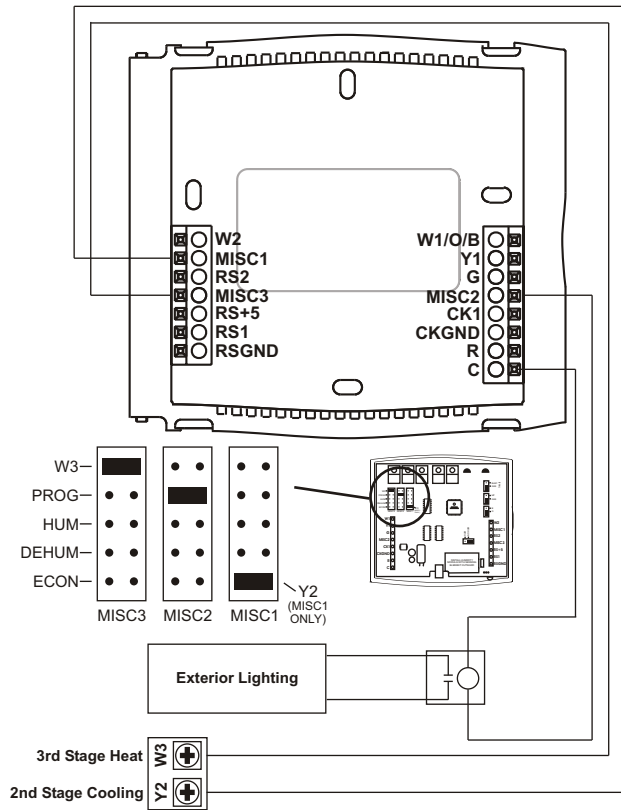

Adding a Humidification System\* (MISC1), Dehumidification System\* (MISC2), and controlling an Economizer (MISC3).

5

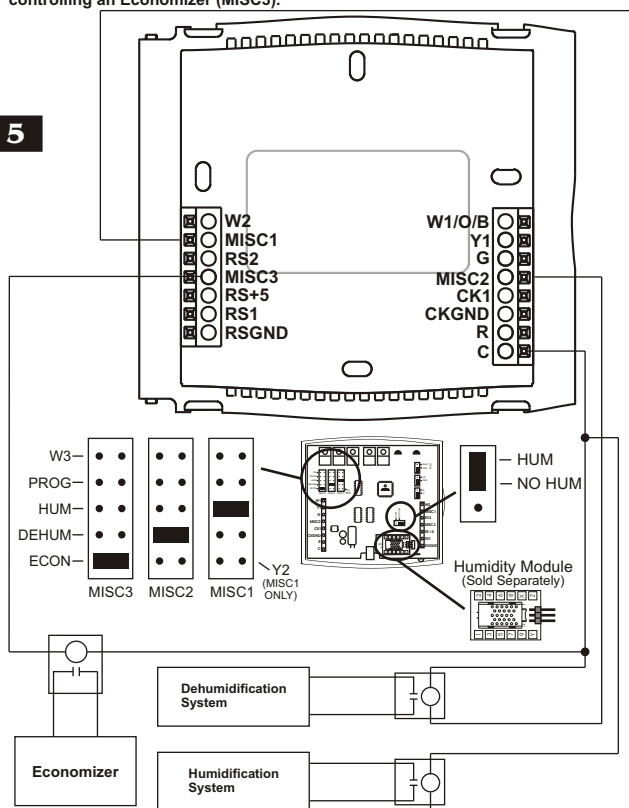

\* Requires Humidity Module.

**CK1 and CK2 terminals wired to a Time Clock**  
 For instructions on wiring the optional Remote and Outside Sensors, please see page 15.2 of the Owner's Manual

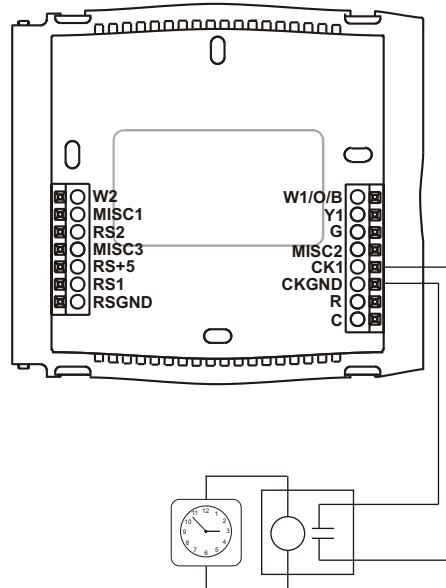

**5**

- DRY CONTACT SWITCH - The terminals are 'normally open' (may be programmed for normally closed operation, see page 16.2 of the Owner's Manual). Closing or completing the circuit will cause the thermostat to do one of the following:
- 1) If Occupied 1 is selected in step #41 of the Advanced Setup (see page 16.4 of Owner's Manual), when the dry contact is energized the thermostat will be forced into Occupied 1 setpoints (see Section 6 of Owner's Manual).
  - 2) If Service Pan is selected, when the dry contact is energized the thermostat will lockout Y1 (compressor) and write Service Pan on the display.

## SECTION 6

### Test Operation

Carrier



Turn the power on to the Heating/Air Conditioning system.

6



Press the **MODE** button repeatedly until the **HEAT** icon appears on the display. Press the UP or DOWN buttons until the set temperature is 10 degrees above room temperature; The furnace should turn on.



Press the **MODE** button repeatedly until the **COOL** icon appears on the display. Press the UP or DOWN buttons until the set temperature is 10 degrees below room temperature; the air conditioner should turn on. **NOTE:** Most equipment has a time delay of 5 minutes between cool cycles. This feature is defeatable on the thermostat. Consult the Owner's Manual under Setup, cycles per hour.



Press the UP button until the setpoint is equal to the room temperature. Press the **FAN** button to **Fan On**. The fan should turn on and run continuously.

**NOTE:** Due to the Random Start feature, outputs may not energize for up to 30 seconds when the thermostat is first powered (see page 16.4 of the Owner's Manual)

## SECTION 7 Calibrating the Thermostat Sensors



Under normal circumstances it will not be necessary to adjust the calibration of the temperature and humidity sensors. If calibration is required, please contact a trained HVAC technician to correctly perform the following procedure.

- 1** **MODE** Place the thermostat in the OFF mode.
- 2** **MODE** Press and hold the MODE button. While holding the MODE button, press and hold the FAN button for 5 seconds. All icons will appear on the display.

**FAN**
- 3** **PRESS** **THERMOSTAT SENSOR**  
**TWICE** Press the UP and DOWN buttons at the same time twice. The thermostat temperature will be displayed and may be calibrated using the UP or DOWN buttons.

**CALIBRATE**

**CALIBRATE**
- 4** **MODE** **REMOTE SENSOR**  
Press the MODE button once. The remote sensor temperature will be displayed and may be calibrated using the UP or DOWN buttons. If a remote sensor is not installed, only dashes will appear.

**CALIBRATE**

**CALIBRATE**
- 5** **MODE** **HUMIDITY SENSOR**  
Press the MODE button once. The relative humidity at the thermostat will be displayed and may be calibrated using the UP or DOWN buttons.

**CALIBRATE**

**CALIBRATE**

After calibration is complete, press the MODE button **twice** to return to normal operation.

## SECTION 8 Troubleshooting

Carrier



**SYMPTOM:** The air conditioning does not attempt to turn on.

**CAUSE:** The compressor timer lockout may prevent the air conditioner from turning on, for a period of time.

**REMEDY:** Consult the Owner's Manual in the Setup section to defeat the cycles per hour and compressor timeguard.

### 8



**SYMPTOM:** The display is blank.

**CAUSE:** Lack of proper power.

**REMEDY:** Make sure power is turned on to the furnace and that you have 24vac between **R & W**. If **C** is used, 24vac between **R & C**.



**SYMPTOM:** The air conditioning does not attempt to turn on.

**CAUSE:** The cooling setpoint is set too high.

**REMEDY:** Consult the Owner's Manual in the Setup section to lower the cooling setpoint limit.



**SYMPTOM:** The heating does not attempt to turn on.

**CAUSE:** The heating setpoint is set too low.

**REMEDY:** Consult the Owner's Manual in the Setup section to raise the heating setpoint limit.

**NOTE:** Due to the Random Start feature, outputs may not energize for up to 30 seconds when the thermostat is first powered (see page 16.4 of the Owner's Manual)

## Troubleshooting

Carrier



**SYMPTOM:** When controlling a residential heat pump, and asking for cooling, the heat comes on.

**CAUSE:** The thermostat reversing valve jumper is set for “b”.

**REMEDY:** Set the reversing valve jumper for “O”. See pages 5.4 and 5.5.



**SYMPTOM:** When calling for cooling, both the heat and cool come on.

**CAUSE:** The thermostat equipment jumper is configured for “HP” and the HVAC unit is a Gas/Electric.

**REMEDY:** Set the equipment jumper for “Gas”. See pages 5.2 and 5.3.

8

**NOTE:** Due to the Random Start feature, outputs may not energize for up to 30 seconds when the thermostat is first powered (see page 16.4 of the Owner's Manual)

P/N 88-507  
Rev. 4